

S E R V I C E O N E , I N C .

REACH
NEW
HEIGHTS

**The Denka Atrium Lift
accesses areas up to
91 feet high, yet passes
through just a 36 inch
wide door!**



R E N T A L S • S A L E S • S E R V I C E

Now there's a faster, easier way to access challenging, hard-to reach jobs. The Denka Atrium Lift provides a cost-effective alternative to scaffolding and more cumbersome lifts.

The Denka is the solution for virtually any aerial application up to 91 feet where narrow access and floor loading is a factor.



THE SKY'S THE LIMIT WHEN YOU RENT THE DENKA ATRIUM LIFT

The one-of-a-kind Denka Atrium Lift gives your company the power and flexibility to tackle jobs that are normally out of your reach, including:

- Cathedral ceilings
- Atrium skylights and window cleaning
- Sign installation and maintenance
- Stadiums and Arenas
- Fire safety system inspections and installation
- Electrical inspections and installation
- Lighting maintenance
- Churches
- Shopping Malls

The Denka Atrium Lift gets you there faster, with minimal disruption. In the time it takes to set up scaffolding, you can often be done with a Denka lift!

TAKES JUST MINUTES TO SET UP AND OPERATE

Every rental includes professional orientation by our staff that gets most operators up to speed within an hour. Or if you prefer, we can supply a qualified operator with your rental.

DENKA ATRIUM LIFT

Manual emergency lowering system

Level bubbles for visual reference

Rear outriggers fold in for maximum maneuverability

Hydraulic outriggers for easy set-up



A fully integrated on-board computer panel regulates the hydraulics and innovative safety features.



Ground control system



Runs full work day on 4 batteries. 24 volt battery charger.

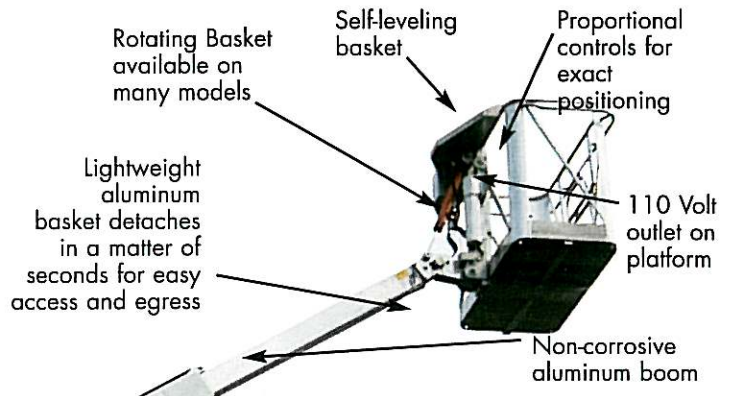

Because it takes just minutes to set up and operate, you can complete even the most demanding jobs quickly and efficiently.

The work site can be restored to normal each day or evening, resulting in minimal disruption to building occupants.

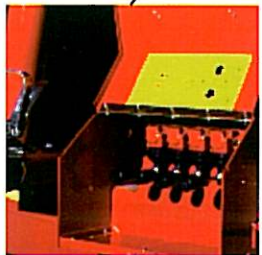

Outrigger Hydraulic Control System, for ease of set up.



Retractable axles to 35 inches. Axles rotate 360°.



Self propelled feature.

DENKA GOES ANYWHERE

Engineered for superior flexibility, the Denka Atrium Lift out maneuvers more cumbersome and limited lifts. It's the only lift of its kind that can reach areas up to 92 feet, yet it passes through a 36-inch doorway. Its continuous 360-degree rotation and light weight, makes Denka the lift of choice for tight areas and expensive marble or granite flooring.

CUTTING EDGE FEATURES ENSURES SAFETY AND STABILITY

The Denka Atrium Lift features have been designed with both ease of service and safety in mind.

- Quiet, battery-driven hydraulic system effectively eliminates the source of troublesome fumes common with other lifts.
- Moment sensors detect overload and neutralize the lift
- Manual emergency lowering system
- Proportional controls for exact positioning
- Mercury switches prevent the lift from being operated when lift is not leveled
- Micro switches prevent use without outriggers
- Tilt alarm sounds when lift is in unstable position
- Parking brake and rear tow bars
- Self propelled controls and swivel basket available on many models
- Meets or exceeds OSHA and ANSI requirements

HOW WE MEASURE UP

Do you have a challenging installation where traditional lifts will not measure up?



The Denka has been successfully installed in numerous projects.

ATRIUM-80

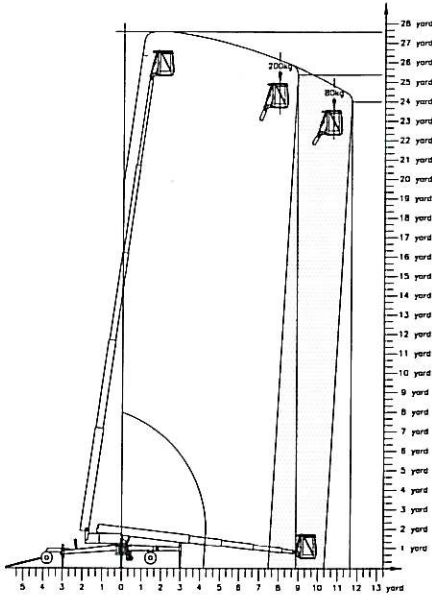

ATRIUM-80 & ATRIUM-90

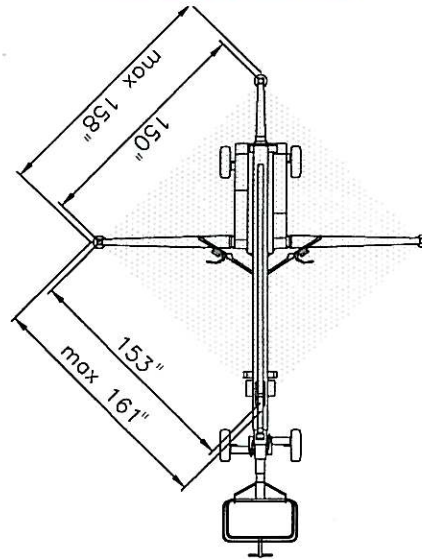

ATRIUM-90

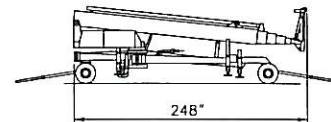
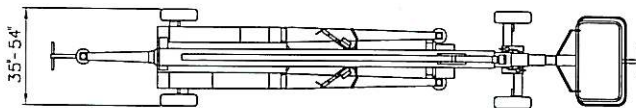
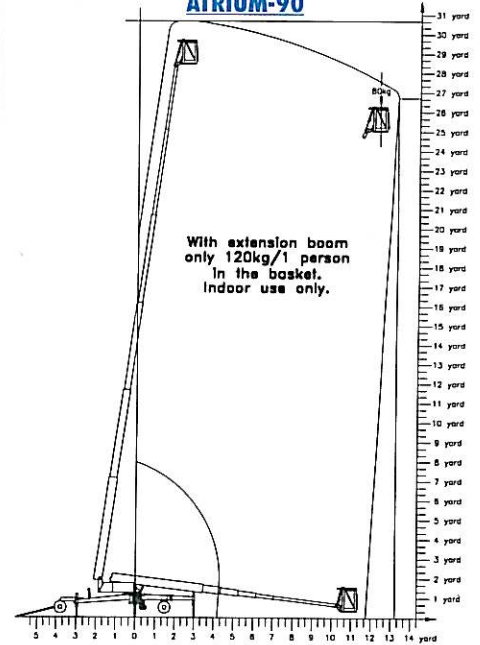

Model	Max Work Ht.	Max Platform Ht.	Max Capacity	Max Outreach	Min Length	Min Height	Min Width	Total Weight
ATRIUM-80:	81'	75'	440 lbs.	30'	17'11" to 21'3"	6'6"	35"	5450 lbs.
ATRIUM-90:	91'	85'	440 lbs.	30'	20'4"	6'6"	35"	5650 lbs.

Custom Aerial Booms and Atrium Lifts available up to 180 foot reach. Access solutions and consulting services available worldwide.

NATIONWIDE
Rentals • Sales • Service

SERVICE ONE, INC.

2850 W. Fulton • Chicago, Illinois 60612

773.533.5100

fax: 773.533.3088

www.denkalift.com

Call us for more information or to arrange for an **ON-SITE EVALUATION.**

8 0 0 . 2 9 8 . 7 9 9 0